

Unibrain Fire-i 521

IEEE-1394, IIDC 1.31 compliant camera
Progressive Scan CCD
C-mount lens - focus adjustment ring
External trigger and partial scan support
Multi camera auto synchronization
High frame rate (86 fps at Format-7 mode 0)



Overview

The new compact industrial camera series from Unibrain are IEEE-1394 and IIDC 1.31 compliant progressive area scan CCD cameras, designed for industrial imaging applications.

The small form factor provides more versatility in space and weight considerations. Using IEEE-1394a digital bus protocol and an external trigger to streamline the capture, digitization and processing of color video signal, these cameras are designed to simplify real-time uncompressed color video streaming, digital still image acquisition while maintaining high resolution in various applications.

The cameras are equipped with a C-Type Lens mount for flexible use of industrial C-Mount lenses and also the firewire port comes with industrial screw lock cable support to ensure stable camera connection.

Features

CCD sensor

- 1/2 inch Wfine color CCD for Fire-i 521c
- 1/2 inch Wfine b/w CCD for Fire-i 521b

Max Frame Rate

- 86 fps at 640 x 480, Format-7 mode 0

Software support

- Unibrain Fire-i software & drivers
- Embedded camera license for Unibrain drivers/SDK
- Unibrain Fire-i API™ Vision/Imaging development kit

Other Features

- High frame rate
- Low Smear and excellent anti-blooming
- External Trigger mode 0~5, 14
- Hardware YUV color conversion & auto white balance (for color models)
- Auto Exposure, Auto Shutter, Brightness, Sharpness
- Multi camera auto synchronization
- Opto-Isolated I/O
- Low power consumption 3.1 W (8-30 VDC) approx.
- Compact black metallic housing

Applications

Machine Vision

ITS

Robotic control

RFID

Microscopy & Inspection

Navigation & GPS mapping

Barcode, OCR, OCV



North & South America: Unibrain, Inc.

2420 Camino Ramon, Suite 121
San Ramon, California 94583, USA.
Phone: +1-925-8663000, Fax: +1-925-8663520

Europe, Asia: Unibrain S.A.

19.5 km Markopoulou Ave.,
19002 Peania, Athens, Greece.
Phone: +30-210-6640600, Fax: +30-210-6646508
email: sales@unibrain.com
Web: <http://www.unibrain.com>

Unibrain Fire-i 521

Mechanical Specifications (Dimensions in mm)

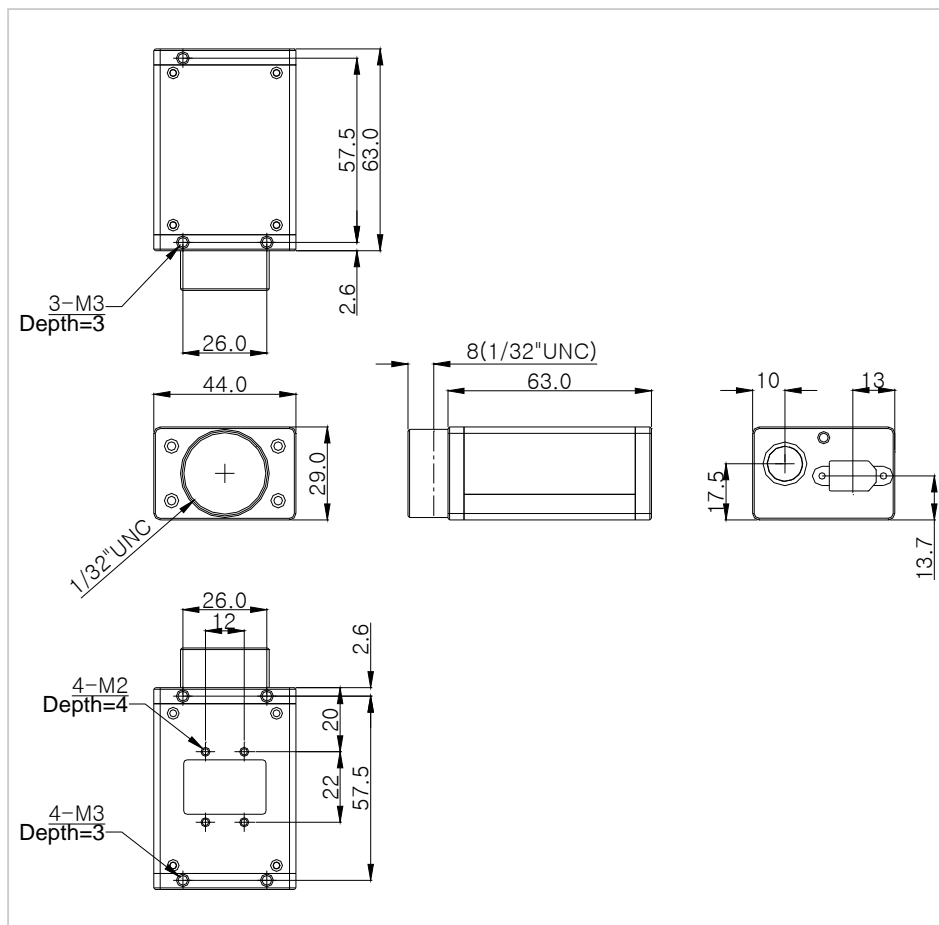

Specifications

Features	Fire-i 521c (color): 4443	Fire-i 521b (Monochrome): 4444
Image Sensor	1/2" progressive scan CCD Sony ICX-414AQ	1/2" progressive scan CCD Sony ICX-414AL
Effective pixels	330,000 pixels 659 (H) x 494 (V)	
Picture Size	640 x 480, 320 x 240	
Data Path	8 bit or 12 bit color Raw & YUV 4:2:2	8 bit or 12 bit b/w
CELL size	9.90 um x 9.90 um	
Frame rate	86 fps (Format-7 mode 0), 60, 30, 15, 7.5, 3.75	
Synchronization	External Trigger at falling edge or S/W Trigger	
Lens Mount	C-mount	
Digital Interface	1 x 1394a 6pin port / IIDC v1.31 – 8~30V DC from cable	
Transfer Rate	400 Mbps/max	
Gain Control	0 ~ 25 dB	0 ~ 27 dB
Shutter Speed	1 usec ~ 65 sec	
Gamma	0.4 ~ 2.5	
Strobe Output Signal	Active High, normal or trigger mode	
External Trigger	Mode 0, 1, 2, 3, 4, 5, 14	
S/N ratio	56 dB or better	
Power Requirements	260 mA max, @ +12V DC	230 mA max, @ +12V DC
Dimensions / Weight	44 (W) x 29 (H) x 63 (D) mm / 110 gr. approx	
Operation Temperature	-5 °C to + 45 °C	
Regulations	FCC, CE, MIC, RoHS	
Supplied Accessories	Lens cover, Unibrain Fire-i drivers & Fire-i API SDK, 4.5m 1394a cable	

